



POWERED MOBILE STORAGE SYSTEMS



MOVE ONE OR MORE OR ALL CARRIAGES AT ONCE WITH A SIMPLE PUSH OF A BUTTON

WITH ITS ENGINEERED GEAR RATIOS AND SUPERIOR QUALITY COMPONENTS, MONTEL CAN EASILY PROCLAIM TO HAVE THE BEST COMBINATION FOR THE SMOOTHEST AND QUIETEST RUNNING MOBILE STORAGE SYSTEMS.



THE BEST POWERED MOBILE STORAGE SYSTEM



A SYSTEM'S PERFORMANCE IS PROVEN OVER TIME, DAY AFTER DAY, YEAR AFTER YEAR

It's measured in superior durability and trouble-free maintenance. It's enhanced with many unique features that make our systems so pleasant to use. The Montel quality makes your life easier.

OPTIMIZE AND CUSTOMIZE YOUR STORAGE SPACE WITH MONTEL'S FLEXIBLE HIGH-DENSITY MOBILE SHELVING SYSTEM

Easily recover floor space with the addition of new Montel shelving, existing shelving or racking securely mounted on Montel carriage and rail systems.

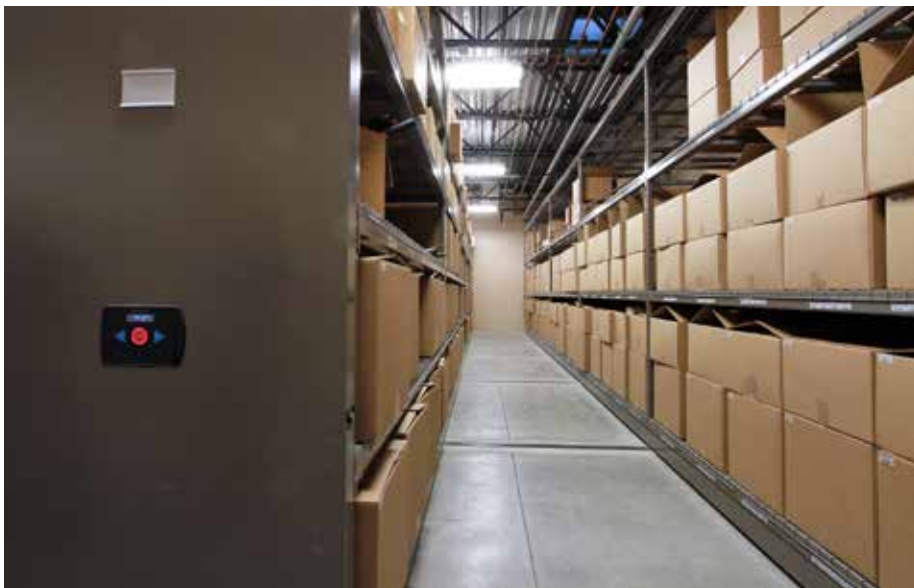

COMPLETE PEACE OF MIND

AS FOR SAFETY, RELIABILITY, USER-FRIENDLINESS

With high-density powered mobile storage systems, getting the most out of your space is a key consideration—but guaranteeing safety is also a must. SafeAisle® will put your mind at ease on both counts. Its **Aisle LED Guard™** and other measures are aimed at providing the utmost in storage security.

Here's how it works: SafeAisle® is equipped with detection cameras that monitor the entire floor surface of an open aisle, unlike many other systems, which overlook certain areas. This 100% coverage ensures there are no missed corners. Whenever a person or an object—no matter how big or small—is in the aisle, built-in safeguards automatically prevent the powered mobile storage system from being moved. This cuts down on the risk of personal injury or property damage.

ENDLESS POSSIBILITIES. COST-EFFECTIVE SOLUTION.

While the revolutionary **Aisle LED Guard™** raises the bar for high-density powered mobile storage system safety, SafeAisle® also gives you the benefits of the superior quality components and trouble-free maintenance of the Montel's Mobilex mechanical-assist mobile storage system.

Montel's products are industry benchmarks in this area. Our track record proves it, comparing favourably to other manufacturers. We've achieved this because we don't believe in cutting corners when it comes to safety. We're sure you don't either—that's why SafeAisle® is the high-density powered mobile storage system for you if you want more capacity without compromising on the safety of users and stored items. A wide range of accessories is also available: reference shelves, multimedia drawers, hanging files and more. Further customize your mobile shelving system via our broad selection of optional safety, security, design and aesthetic features.



WHY SAFEAISLE®?

SAFEAISLE® IS ENGINEERED PRECISELY FOR HANDLING THE HEAVY LOADS WITH THE LIGHTEST EFFORT.

- MOST TECHNOLOGICALLY ADVANCED ELECTRICAL MOBILE SYSTEMS
- SAFEST ELECTRICAL MOBILE SYSTEM WHEN SUPPLIED WITH THE PATENTED **AISLE LED GUARD™**
(US PATENT NO. 9,507,05 / CANADIAN PATENT NO. 2,778,977)
- DURABILITY & TROUBLE FREE MAINTENANCE
- THE MOST USER-FRIENDLY HIGH-DENSITY MOBILE STORAGE SYSTEM
- BUILT FOR DECADES OF USE
- A HIGHLY SECURE MOBILE STORAGE SYSTEM
- INCREASE PRODUCTIVITY BY SAVING TIME

DID YOU KNOW?

SAFEAISLE® CARRIAGES HAVE A MAXIMUM LOAD CAPACITY OF 1,000 LB PER LINEAR FOOT (1,488 KG PER LINEAR METER)

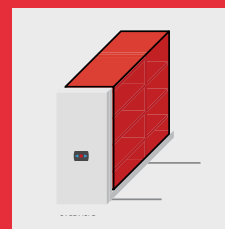

EX: 25 FT (7.62 M)
LONG CARRIAGE
HOLDS 25,000 LB
(11,340 KG)

SAFEAISLE®

SAFEAISLE® ELECTRICAL POWERED CARRIAGES CAN BE UP TO 60 FEET (18.29 M) LONG WITH A MAXIMUM LOAD CAPACITY OF 60,000 LB (27,216 KG).

THE CONCEPT

OPTIMIZE YOUR STORAGE SPACE

MONTEL HIGH-DENSITY STORAGE SYSTEMS MAXIMIZE THE USE OF AVAILABLE SPACE, WHETHER TO INCREASE STORAGE CAPACITY, FREE UP ROOM FOR PRODUCTION OR OTHER USES, OR GET RID OF SPACE YOU DO NOT NEED TO PAY FOR.

ELIMINATE THE NEED FOR MULTIPLE SPACE-WASTING STATIC AISLES.

1. Static units are mounted on mobile carriages.
2. Mobile carriages travel on tracks.
3. Open the desired aisle.
4. Press the aisle safety push-button located at the center of the handle.



WASTED SPACE
CONVENTIONAL FIXED
RACKING LAYOUT.

Conventional storage systems require space-wasting fixed aisles.

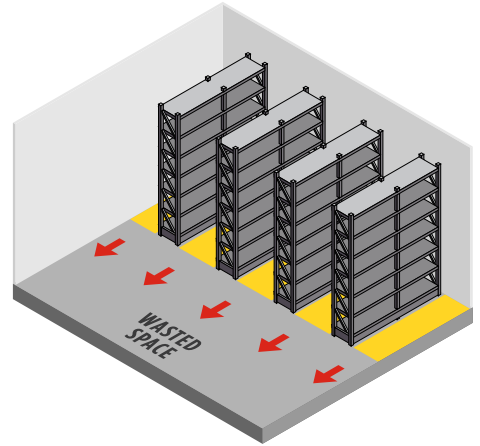

MODES OF OPERATION*



Powered mobile storage systems
3-button control.



Powered mobile storage systems control with PIN for restricted access.



Powered mobile storage systems touchscreen tablet control with or without PIN code. Limitless customizable displays.

Best Buy and the Best Buy logo are trademarks of Best Buy.



SPACE SAVED & INCREASED PROFITS
MOBILE STORAGE LAYOUT.

50% of floor space saved within same footprint.

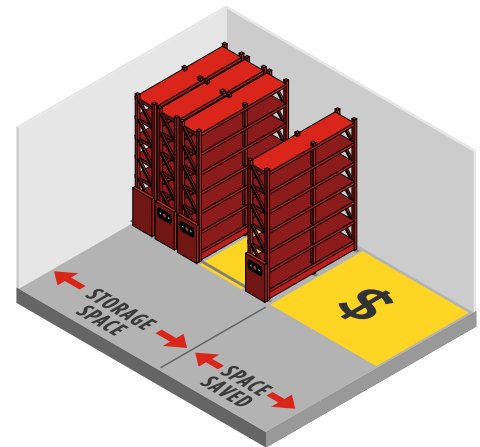

DOUBLED STORAGE CAPACITY.
MAXIMIZED SPACE & INCREASED PROFITS
MOBILE LAYOUT.

100% greater storage within same footprint.

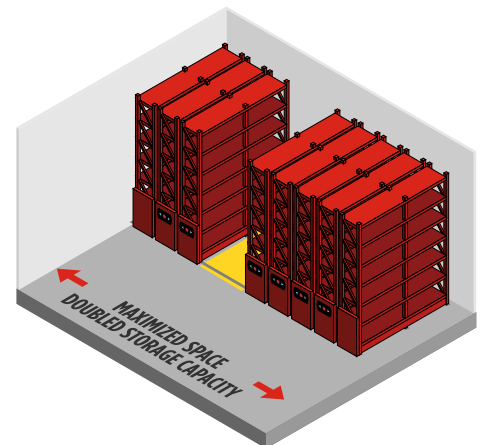

AVAILABLE WITH MOBILEX® MOBILE SYSTEMS
REFER TO MOBILEX® BROCHURE FOR MORE INFORMATION

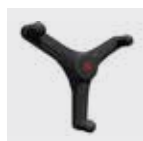

Large SafeCrank Handle
with aisle safety push-button.



Small SafeCrank Handle
with aisle safety push-button.
Ideal for narrow panels less than 20" wide (508 mm).

* The optional and patented Aisle LED Guard™ (US Patent No. 9,507,05 / Canadian Patent No. 2,778,977) guarantees complete safety coverage throughout the aisle protecting users and objects.

BEST-IN-CLASS SAFETIES

EXPERIENCE THE INDUSTRY'S SAFEST POWERED MOBILE STORAGE SYSTEM

STANDARD SAFETIES

AISLE-ENTRY PEOPLE COUNTER

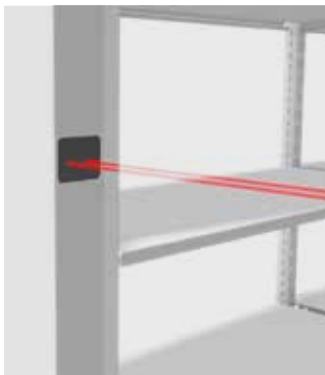

Carriage movement instantly stops when the system detects any beam disruption in front of the storage system when a user is entering an aisle.

INFRARED FOOT-LEVEL SAFETY BEAM ONE SIDE OF MOBILE CARRIAGE



Photoelectric beam projecting on one side of each aisle is mounted low on the carriage side member.

NOTE: SUITABLE ONLY FOR VERY LOW TRAFFIC RESTRICTED AREAS AND SHORT MOBILE CARRIAGES BUT NOT RECOMMENDED FOR PUBLIC ACCESS SPACES.

OPTIONAL SAFETIES

INFRARED FOOT-LEVEL SAFETY BEAMS BOTH SIDES OF MOBILE CARRIAGE

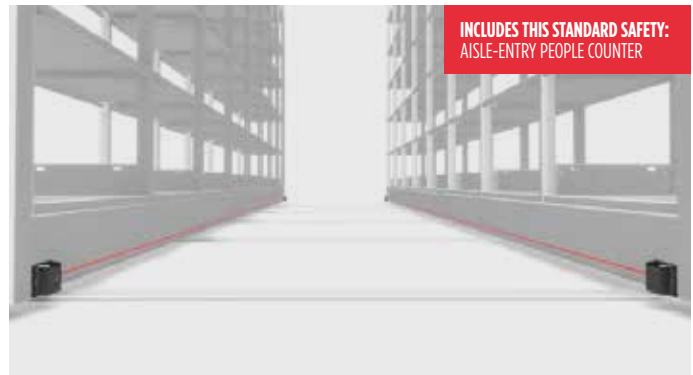

Photoelectric beams projecting on both sides of each aisle are mounted low on the carriage side members.

NOTE: SUITABLE ONLY FOR LOW TO MEDIUM TRAFFIC RESTRICTED AREAS BUT NOT RECOMMENDED FOR PUBLIC ACCESS SPACES.

SYSTEM BACKUP

DOWNTIME IS NOT AN OPTION

STANDARD AUXILIARY OVERRIDE MECHANICAL RATCHET BACKUP



The standard mechanical ratchet ensures complete accessibility even in the event of a power failure. Additional benefits include no operational downtime, simplified system installation, shorter installation time, and easy relocation.

OPTIONAL AUXILIARY POWER AUTOMATIC BUILT-IN BATTERY BACKUP (UPS)

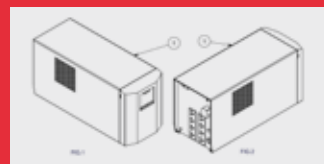

The automatic built-in battery backup override ensures that SafeAisle® remains powered up and operational during power failures. The plug-in-the-wall (UPS) unit also provides protection during power surges. When the system runs on auxiliary power, all safeties remain fully functional.

ADVANCED OPTIONAL SAFETY

AISLE LED GUARD™

COMPLETE AISLE-DETECTION PASSIVE SAFETY



NOTE 1: AISLE LED GUARD™ IS REQUIRED FOR PUBLIC ACCESS AREAS.

NOTE 2: FLOOR LEVEL-SAFETY BEAM(S) ARE NOT REQUIRED WITH AISLE LED GUARD™.

AISLE LED GUARD™ IS PATENTED
US Patent No. 9,507,057 /
Canadian Patent NO.2,778,977

MONTEL REVOLUTIONIZES MOBILE STORAGE WITH AISLE LED GUARD™ FOR SMARTSPACE 2P, SAFEAISLE® AND RACK&ROLL 16P

Montel's powered mobile systems supplied with the advanced optional safety **Aisle LED Guard™** passive safety adds a new dimension by continuously detecting the whole floor surface footprint of an aisle.

LED sensors detect people and objects in open aisles. While aisles are in use or occupied, racking modules are locked in place, thereby protecting users from injury and stored materials from damage. Regardless of what you and your organizations stores **Aisle LED Guard™** ensures no avoidable harm comes to any of it should it fall from your shelves.



COMPLETELY PASSIVE

Aisle LED Guard™ is 100% passive. Users do not have to remember to locate and activate any safety devices when interacting with the mobile shelving or racking system. Even with fully loaded racking, **Aisle LED Guard™** will protect users and objects left in the aisle without human intervention.

FULL COVERAGE

Where users stand in an open aisle will not impact the effectiveness of **Aisle LED Guard™**. No matter where a user are located in the aisle, no matter where in the aisle a product falls, no matter if a pallet is left in the aisle, the units will not close without complete clearance.

FOOLPROOF DESIGN

Aisle LED Guard™ used in Montel products cannot be deactivated, overwritten or bypassed. No sequence of button mashing or reconfiguration will shut it down. **Aisle LED Guard™** places mobile shelving installations in a constant state of vigilance.

IMPROVE PRODUCTIVITY

SmartSpace 2P, SafeAisle® and RACK&ROLL 16P systems provided with **Aisle LED Guard™** automatically reset as soon as a user or object is cleared from an aisle. Users waste no time manually resetting an aisle after each use.



DID YOU KNOW?

ELECTRONIC OVERLOAD PROTECTION

All controls are programmed with an electronic overload protection which shuts off power to the motor when excessive pressure is applied against a carriage. This pressure sensitivity is also easily adjustable with any PIN-code control or the ePulse™ Remote Monitoring Software.

USER-FRIENDLY CONTROLS

USER-FRIENDLY CONTROLS

The LED-friendly visual backlit indicators display the available options for carriage movement. Only the safe choices are illuminated. If it is not a safe option, than it is not an available option. SafeAisle® takes the guesswork out of safe mobile operations. This ADA-friendly LED visual backlit indicators allow easy visual status from even across the room. ♿

The powered system is operated either with the standard 3-button control for public access or the PIN-code control for secure access.



SIMPLE 3-BUTTON CONTROL

“READY TO USE” STATUS



PIN-CODE CONTROL

“AISLE IN USE” STATUS

PIN CODE CONTROL | PROGRAMMABLE SETTINGS

- PIN Code Management
- Programmable Speeds (startup, cruising, braking)
- Aisle Spacing
- Main Priority Aisle
- Auto Spacing | Ventilation Park Fire Park
- Auto Closing | Security Park
- Sequential Move or Block Move
- Override Mode
- Date & Time
- Language
- Customized Messages on LCD Displays
- Motor Overload Sensitivity
- Programmable Inputs & Outputs (Building Interface: Fire, Security, Lighting)
- Programmable Aisles & Shelves Lighting
- And more...

NOTE 1: EACH MODULE INCLUDING MULTIPLE MOBILE SYSTEM UNITS CAN BE PROVIDED WITH AT LEAST ONE PIN CODE CONTROL AND ALL OTHER UNITS WITH STANDARD CONTROLS. SO EACH MODULE AND EVERY INDIVIDUAL MOBILE UNIT OF A MODULE ARE PROGRAMMABLE WITH THE MASTER PIN CODE CONTROL. | **NOTE 2:** A MODULE INCLUDING MULTIPLE MOBILE SYSTEM UNITS CAN BE PROVIDED WITH ALL PIN CODE CONTROLS. | **NOTE 3:** EVEN MORE PROGRAMMABLE SETTINGS AND AUTOMATED MOVES USING THE EPULSE REMOTE MONITORING SOFTWARE. SEE P13.

CRYSTAL CLEAR SYSTEM STATUS

SafeAisle® controls always display current aisle and system status in real-time. SafeAisle® takes the guesswork out of safe mobile operations. LED-friendly visual backlit indicators display the available options for carriage movement, and allow easy visual status from even across the room.

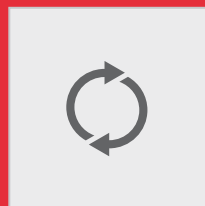

AUTOMATIC AISLE RESET



LED-FRIENDLY VISUAL BACKLIT INDICATORS (LOCKED, SYSTEM ERROR)

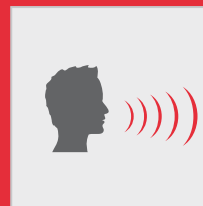

AUDIO FEEDBACK FEATURE AVAILABLE (MULTILANGUAGE)



AISLE IN USE STATUS

AVAILABLE CONTROLS

STANDARD CONTROL



The standard control is perfectly suited for public access environments.

The LED-friendly visual backlit indicators display the available options for carriage movement. Only the safe choices are illuminated. If it is not a safe option, thank it is not an available option.

TOUCHSCREEN TABLET CONTROL



Powered mobile storage systems touchscreen tablet control with or without PIN code.

CONTROL WITH PIN



The PIN code control restricts access to specific aisles or the entire system for secure environments.

The LED-friendly visual backlit indicators display the available options for carriage movement. Only the safe choices are illuminated. If it is not a safe option, thank it is not an available option.



Best Buy and the Best Buy logo are trademarks of Best Buy.



Limitless customized displays.

DUAL ACCESS

OPTIONAL

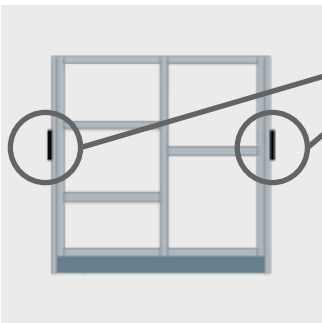

- Mobile system accessible at each end of mobile units
- Controls located at each extremity

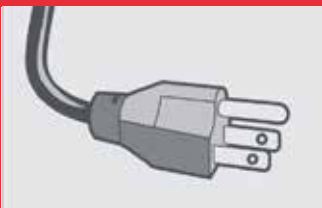

PLUG-IN-THE-WALL POWER RECEPTACLE-READY



TCP/IP PROTOCOL CONNECTIVITY

DID YOU KNOW?

CONNECTIVITY

SafeAisle® is ready to be powered up easily and so simple to use.

The TCP/IP protocol facilitates the network connectivity from computer to computer via the internet, provides reliable high-speed communication, and permits remote access to your SafeAisle® using the ePulse Remote Monitoring Software.

BETTER ORGANIZE YOUR SKUs



DID YOU KNOW?

ACCESSIBILITY

This ADA-friendly LED visual backlit indicators allow easy visual status from even across the room. Designed to comply with ADA requirements such as available audio feedback, control height, aisle width, ramp.



ePulse™ REMOTE MONITORING SOFTWARE



**INCREASE
PRODUCTIVITY**





INCREASE PRODUCTIVITY WIRELESSLY

Created to provide additional certainty and safety monitoring once Montel's high-density powered mobile storage systems are installed, Montel now offers ePulse™. This remote monitoring & configuration software has the functionality of providing the capability to manage settings remotely and monitor your high-density powered mobile system's performance and operations with assurance. If remote network connectivity access to Montel is granted, certified technicians could monitor and configure your system remotely from their own location.

For maximum reliability and peace of mind, ePulse™ proactively identifies any potential issues with your system, provides quick diagnostics of the system to maximize your uptime, sends automatic email notifications of system errors. You could even decide to monitor and configure your own Montel powered mobile system 24 hours a day, every day of the year.

To increase productivity & efficiency, ePulse™ allows to collect aisle entry data for any preset period of time from your Montel powered mobile system. Once this data is analyzed for each aisle, ePulse™ permits to reconfigure your powered mobile system to your preferred settings.

For additional security, with the collected & analyzed aisle entry data from your powered mobile system, ePulse™ allows to reconfigure the security settings of your system at anytime. Whether it be adjusting the programmable speeds, or remotely configuring your system to close all aisles and lock at a specific time after business hours, or open and unlock before business hours, ePulse™ offers security with peace of mind.

Montel powered systems can be operated remotely from the fingertips on your computer with the ePulse™.

SafeAisle® can be interfaced and coordinated with your building's fire, sprinkler, lighting, or alarm security systems. For example, the system can be programmed to move to preset equal spacing between the carriages when the fire/sprinkler system is activated, or completely closed and locks itself in the event of a security breach.

Montel's ePulse™ remote monitoring & configuration software is also available with SmartSpace 2P, RACK&ROLL 16P, SAFERAK® 32P, SAFERAK® 60P Montel systems.



EPULSE REMOTE MONITORING SOFTWARE PROGRAMMABLE SETTINGS

- PIN Code Management
- Programmable Speeds (startup, cruising, braking)
- Aisle Spacing
- Main Priority Aisle
- Auto Spacing | Ventilation Park Fire Park
- Auto Closing | Security Park
- Sequential Move or Block Move
- Override Mode
- Date & Time
- Language
- Customized Messages on LCD Displays
- Programmable Inputs & Outputs (Building Interface: Fire/Sprinkler System, Security/Alarm System, Lighting).
- Programmable Aisles & Shelves Lighting
- Motor Overload Sensitivity
- Aisle Entry Data Logging
- Computer Interface
- Warehouse Management Software Interface (WMS)
- And more...



ePulse™ REMOTE MONITORING PACKAGES

The screenshot displays the ePulse remote monitoring software interface. At the top left, there is a 'Status' button and a 'Mount Demo' button. The main interface is divided into two columns, 'MACHINE 1' and 'MACHINE 2'. Each machine panel includes a central image of the machine and several status indicators:

- LEFT SIDE:**
 - WHEEL STATUS: STATUS
 - DISTANCE: 0.26 m
 - CALL DISTANCE: 8.52 m
 - ASLE OPEN: (Green indicator)
 - OBSTRUCTION: (Grey indicator)
 - ASLE IN USE: (Grey indicator)
 - SAFETY: (Green indicator)
 - FLOOR LEVEL SAFETY: ENABLED (Green indicator)
 - LID/GUARD: DISABLED (Grey indicator)
 - HRD: DISABLED (Grey indicator)
 - FRONT COUNTER: DISABLED (Grey indicator)
 - REAR COUNTER: DISABLED (Grey indicator)
 - FRG AUTO-LOCK: DISABLED (Grey indicator)
- RIGHT SIDE:**
 - WHEEL STATUS: STATUS
 - DISTANCE: 0.26 m
 - CALL DISTANCE: 7.89 m
 - ASLE OPEN: (Grey indicator)
 - OBSTRUCTION: (Grey indicator)
 - ASLE IN USE: (Grey indicator)
 - SAFETY: (Green indicator)
 - FLOOR LEVEL SAFETY: DISABLED (Grey indicator)
 - LID/GUARD: 2 CAMERAS (Green indicator)
 - HRD: DISABLED (Grey indicator)
 - FRONT COUNTER: DISABLED (Grey indicator)
 - REAR COUNTER: COUNTER (Green indicator)
 - FRG AUTO-LOCK: DISABLED (Grey indicator)
- INPUTS/OUTPUTS:**
 - IN3 (I78): DISABLED (Grey indicator)
 - IN4 (I78): DISABLED (Grey indicator)
 - KEYS FRONT (F8): DISABLED (Grey indicator)
 - KEYS FRONT (F8): DISABLED (Grey indicator)
 - OUT1 (O8): IN USE RIGHT (Green indicator)
 - IN5 (I78): DISABLED (Grey indicator)
 - IN6 (I78): DISABLED (Grey indicator)
 - KEYS REAR (F8): DISABLED (Grey indicator)
 - KEYS REAR (F8): DISABLED (Grey indicator)
 - OUT2 (O8): IN USE RIGHT (Green indicator)

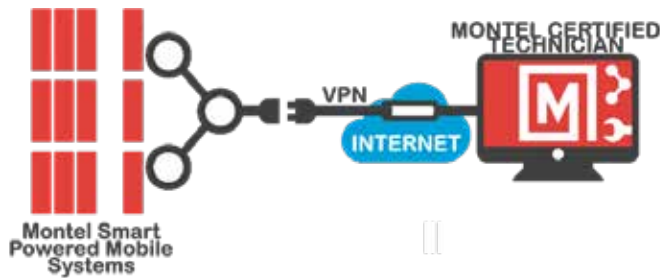

BRONZE - LOCAL REMOTE MONITORING WITHOUT EXTERNAL CONNECTIVITY

OBJECTIVE:

- Local remote monitoring for customers wanting to manage on their own the Montel powered mobile storage systems.
- No external internet access connectivity is authorized by the client to Montel's certified technicians.

APPLICATIONS: Highly secure facilities.

CLIENTELE: Large businesses, public services, governmental services, academic institutions, military bases

PROPOSED BRONZE PACKAGE: «ePulse™ Remote Monitoring Software» installed on a dedicated local computer.

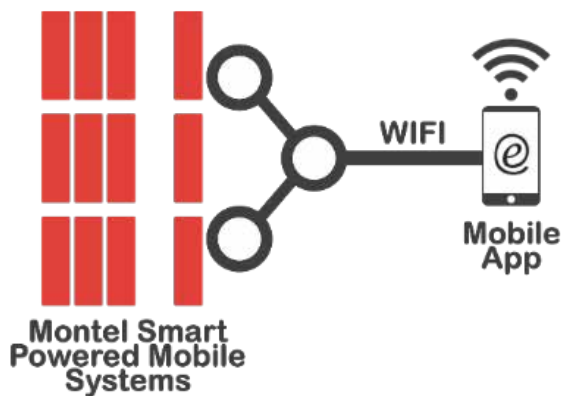

SILVER - LOCAL REMOTE MONITORING WITH POSSIBILITY OF À LA CARTE EXTERNAL CONNECTIVITY

OBJECTIVE:

- Local remote monitoring for customers wanting to manage the Montel powered storage systems with the possibility of granting access externally to Montel's certified technicians.
- Upon receipt of a phone call or email from the customer, Montel certified technicians would have the capability to connect, monitor and configure the Montel powered mobile storage systems.

CLIENTELE: Small and medium size businesses. customers located in remote or restricted areas, or distant from their authorized montel distributor or Montel Inc.

PROPOSED SILVER PACKAGE: «ePulse™ Remote Monitoring Software» installed on a dedicated local computer and a vpn remote access router.

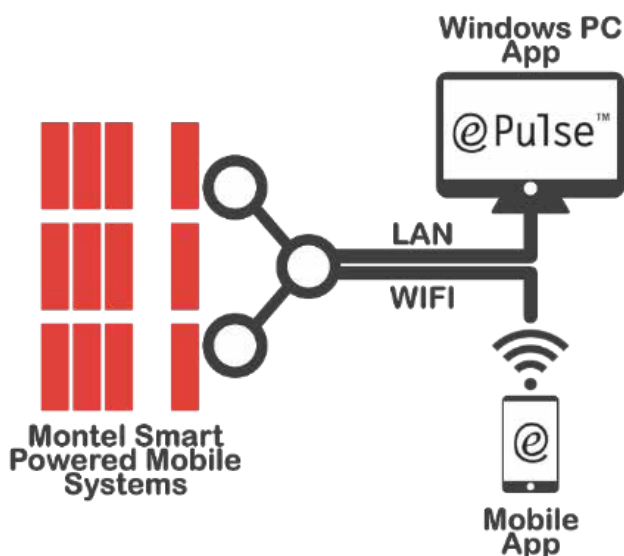

GOLD - À LA CARTE REMOTE MONITORING EXTERNAL CONNECTIVITY

OBJECTIVE:

- External remote monitoring for customers wanting Montel's certified technicians to connect, monitor and configure their Montel powered storage systems.

CLIENTELE: Small and medium size businesses. customers located in remote or restricted areas, or distant from their authorized montel distributor or Montel Inc.

PROPOSED GOLD PACKAGE: VPN remote access router and external à la carte remote monitoring services provided by Montel certified technicians.

PROGRAMMABLE AISLE AUTOMATED FEATURES

**MORE EFFICIENT THAN A MECHANICAL OR
MANUAL MOBILE STORAGE SYSTEM, SAFE AISLE®
IS A TIME-SAVER AS WELL AS A COST-SAVER**

INCREASE PRODUCTIVITY BY SAVING TIME AND COSTS

For additional convenience, the system keeps opening to its full width once the user enters an aisle. If a user enters a closing aisle, the carriages immediately stop, as well as the system can be preprogrammed to also gently reverse itself to the full width of the original aisle for greater accessibility.



AUTOMATIC AISLE RESET

Upon confirmation there is no additional person or object within the aisle, SafeAisle resets automatically as soon as a user exits the aisle. The LED-friendly visual backlit arrows on the control face panels instantly switch to blue and indicate the available aisles.



MULTI-TASKING AISLES

You have inadvertently not selected your desired aisle. Even while carriages are still moving, you are able to reselect your intended aisle by pressing the directional arrows on any face panel control and the mobile system will respond immediately to your new command. This multi-tasking aisle feature allows you to select new aisles without waiting for the mobile system to complete its move cycle.

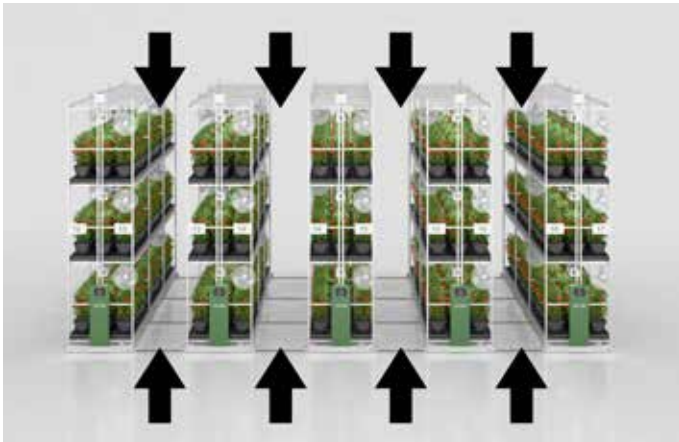

VENTILATING AISLES

You can program your system to equally space all aisles. Ventilate your precious stored materials whenever you want at predetermined times.



PRIORITIZING AISLES

Users can increase their efficiency by configuring a specific priority aisle(s). While accessing an infrequently used aisle, SafeAisle® mobile racking automatically repositions the system to your desired predetermined aisle(s). The most frequently utilized aisle(s) will be preset to reopen automatically for the next user. You can eventually reconfigure your SafeAisle® powered mobile racking mobile system by programming aisles according to picking rates or pulls. This ensures quick access to your commonly stored materials. Program the Priority Aisle automatic feature with the PIN-Code Control or the optional ePulse™ Remote Monitoring Software.



CLOSING ALL AISLES

Program your system to automatically close all aisles and lock once a user exits an aisle, or after a preconfigured period of inactivity. Configure your system to close all aisles and lock at a specific time after business hours, or open and unlock before business hours.

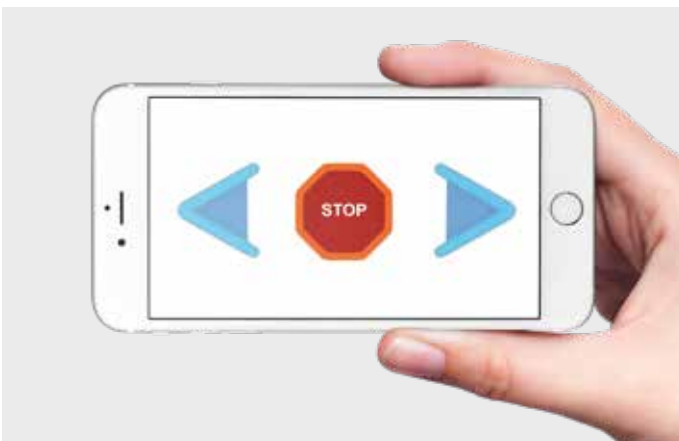

OPERATING AISLES REMOTELY SMARTPHONE WI-FI REMOTE CONTROL

The powered system can also be operated using a smartphone Wi-Fi remote control (specific brands and models only) which can be a convenient feature for equipment operators.

SAFE AISLE®

VALUE YOU CAN COUNT ON



Of all the mobile storage system on the market, SafeAisle® stands in a class of its own. This pioneering system with a proven design constantly evolving with changing needs. A wise investment anytime, it gives you incredible value for your storage dollar. SafeAisle® adapts perfectly to your access, conservation, and safety priorities, regardless of the size, weight, dimensions, and value of your objects. Reliable, durable, and flexible, SafeAisle® optimizes your storage space in complete safety.

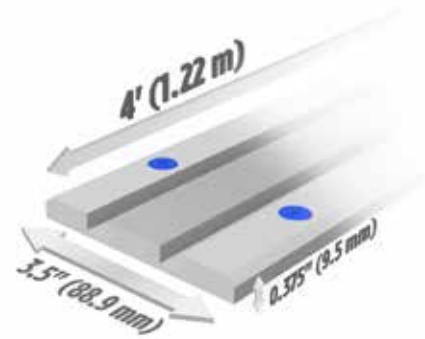

SURFACE MOUNTED RAIL

One-piece solid steel rail system for surface mount applications on a leveled slab. Anchored directly to the concrete slab with a chamfered edge flush fit design to reduce tripping hazards and allow carts to easily roll over. Steel rail treated against oxidation with a heavy-duty powder coated paint.

SURFACE MOUNTED RAILS ARE AVAILABLE IN 4-FOOT SECTIONS (122 CM)

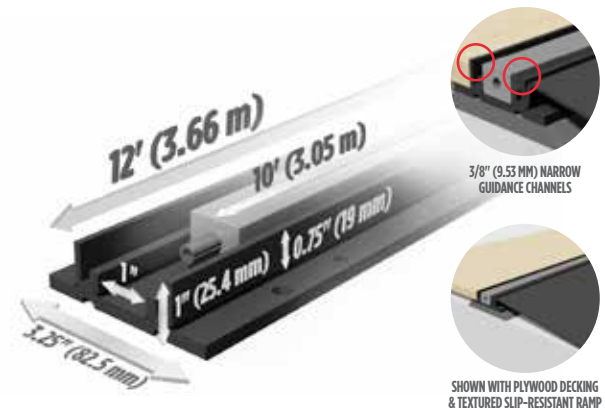

RECESSED OR FLOOR MOUNTED TRACK

Leveled track design with a solid steel rail embedded into grouted aluminum sub-rail for superior strength and load distribution to the concrete slab. Narrow guidance channels reduce tripping hazards and allow carts to easily roll over.

ALUMINUM SUB-RAILS ARE AVAILABLE IN 12-FOOT SECTIONS (3.66 M)
STEEL RAILS ARE AVAILABLE IN 10-FOOT SECTIONS (3.05 M)

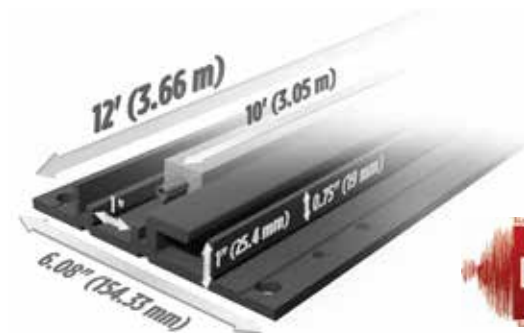

BUILT-IN ANTI-TIP RECESSED OR FLOOR MOUNTED TRACK

Built-in anti-tip leveled track design with a solid steel rail embedded into a grouted aluminum sub-rail with anti-tip channels for both seismic and high shelving applications which also provides for superior strength and load distribution to the concrete slab. Narrow guidance channels reduce tripping hazards and allow carts to easily roll over.

ALUMINUM SUB-RAILS ARE AVAILABLE IN 12-FOOT SECTIONS (3.66 M)
STEEL RAILS ARE AVAILABLE IN 10-FOOT SECTIONS (3.05 M)

TRACK & FLOOR SURFACE OPTIONS

SURFACE MOUNTED RAIL MOUNTED ON TOP OF A LEVELED CONCRETE FLOOR

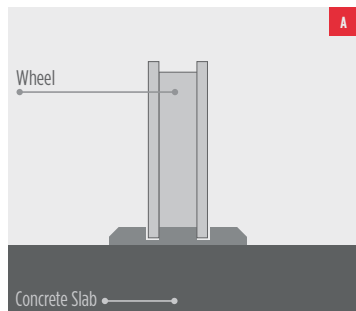

RECESSED TRACK EMBEDDED IN CONCRETE

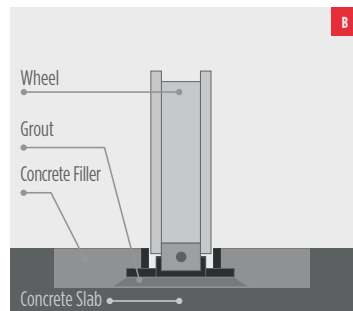

FLOOR MOUNTED TRACK CONCRETE PAD

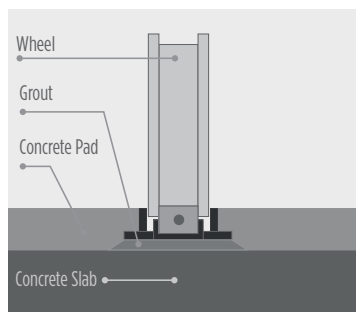

FLOOR MOUNTED TRACK PLYWOOD DECKING

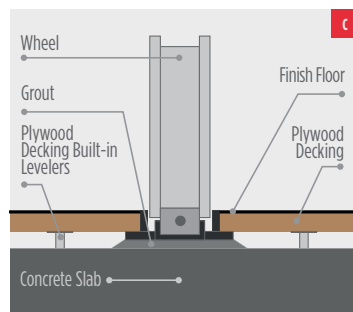

MONTEL PRODUCT SHOWN IS A HD 16MA WITH SURFACE MOUNTED STEEL RAIL ON CONCRETE FLOOR.



RECESSED TRACK EMBEDDED IN CONCRETE.

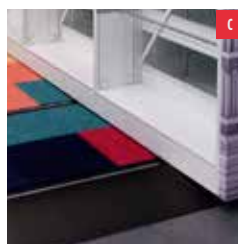

FLOOR COVERING MATERIALS SUCH AS CARPET, TILE, LAMINATE AND VINYL CAN BE APPLIED OVER PLYWOOD DECKING.

SAFEAISLE® FEATURES & BENEFITS & TRACK OPTIONS COMPARISON CHART

				SURFACE MOUNTED	RECESSED	FLOOR MOUNTED	
SURFACE MOUNTED		SURFACE MOUNTED RAIL <ul style="list-style-type: none"> • Unleveled surface mount rail for leveled floor • 3/8" (9.5 mm) high x 3 1/2" (88.9 mm) wide 	<ul style="list-style-type: none"> • Heavy-duty paint against oxidation caused by concrete • Easy installation 	<ul style="list-style-type: none"> • Beveled Edges design and narrow channels to reduce risk of tripping hazards • Wood floor, grout or shims are not required 	✓		
	OR						
RECESSED OR FLOOR MOUNTED TRACK OPTIONS		CORROSION-RESISTANT ALUMINUM SUB-RAIL <ul style="list-style-type: none"> • Acts as barrier between the concrete and the hardened steel rail 	<ul style="list-style-type: none"> • Prevents rust in a corrosive concrete environment 		✓	✓	
	OR						
RECESSED OR FLOOR MOUNTED TRACK		BUILT-IN ANTI-TIP ALUMINUM SUB-RAIL <ul style="list-style-type: none"> • Provides stability and safety • Meets the most severe seismic regulations 	<ul style="list-style-type: none"> • Provides safety for systems with a high height-to width ratio 	<ul style="list-style-type: none"> • Meets UBC requirements  	✓	✓	
	RECESSED OR FLOOR MOUNTED TRACK		TWO ANTI-SLIP GROOVES <ul style="list-style-type: none"> • Grout infiltrates under the sub-rail and inside the grooves thus preventing lateral movement if pouring concrete topping 			✓	✓
		INTERLOCK STEEL RAIL CONNECTOR <ul style="list-style-type: none"> • Eliminates rail separation 	<ul style="list-style-type: none"> • Ensures gradual transfer of the concentrated wheel point load to and from adjoining rail sections 	<ul style="list-style-type: none"> • Provides horizontal and vertical continuity between rail sections 	✓	✓	
		PIN ANCHORING AT EACH TRACK END <ul style="list-style-type: none"> • Ensures perfect position of rail 			✓	✓	
		TWO-PIECE SPLICELESS TRACK <ul style="list-style-type: none"> • Continuously supports the top hardened steel rail at the junction point • Eliminates track deflection • Provides a quiet operating system 	<ul style="list-style-type: none"> • Ensures smooth weight transfer from one track section to the other • Easy and instant removal and replacement of the top hardened steel rail compared to a one-piece rail 	<ul style="list-style-type: none"> • Ensures that all rail connection joints provide horizontal and vertical continuity between rail sections • Provides greater structural rigidity 	✓	✓	
		OFFSET SUB-RAIL AND RAIL SPLICE JOINTS FROM ONE ADJOINING <ul style="list-style-type: none"> • Prevents the adjoining rail splice to be at the same location 	<ul style="list-style-type: none"> • Prevents the wheels of a same carriage to cross a rail splice joint at the same time 	<ul style="list-style-type: none"> • Ensures a better weight load distribution • Eliminates any rail deflection 	✓	✓	
		FULLY-GROUTED ALUMINIUM SUB-RAIL <ul style="list-style-type: none"> • Fully supported to evenly distribute the weight on the existing slab 	<ul style="list-style-type: none"> • No shims needed 		✓	✓	
LEVELING & ANCHORING FLOOR MOUNTED TRACK			PRECISION LEVELING SCREWS <ul style="list-style-type: none"> • Provide more precision and adjustability versus shimming 	<ul style="list-style-type: none"> • Provide a quality rail installation which ensures long-term reliability 		✓	✓
		PLYWOOD DECKING BUILT-IN LEVELERS <ul style="list-style-type: none"> • Provide more precision and adjustability than shimming 	<ul style="list-style-type: none"> • Provide an accurate and continuous flush floor surface 	<ul style="list-style-type: none"> • Faster and more efficient to install 		✓	
TEXTURED SLIP-RESISTANT STEEL RAMP FLOOR MOUNTED TRACK		STEEL RAMP WITH TEXTURED SLIP-RESISTANT PAINT <ul style="list-style-type: none"> • 8.8" (22.35 cm) wide steel ramp with textured anti-slip black paint • 10-degree slope • Made of 12 gauge cold rolled steel 	<ul style="list-style-type: none"> • Ramp makes a smooth transition from the floor to the mobile system's false floor to prevent tripping and allow carts to easily roll over 	<ul style="list-style-type: none"> • Ramp can be covered with carpet or vinyl flooring tiles • Optional 3M™ Safety-Walk™ slip-resistant tape 		✓	
	OR						
		ADA STEEL RAMP WITH TEXTURED SLIP-RESISTANT PAINT ♿ <ul style="list-style-type: none"> • 19" (48.26 cm) wide ADA steel ramp with textured anti-slip black paint • 5-degree slope to meet ADA regulations • Made of 12 gauge cold rolled steel 	<ul style="list-style-type: none"> • Ramp makes a smooth transition from the floor to the mobile system's false floor to facilitate wheelchair access, prevent tripping, and allow carts to easily roll over 	<ul style="list-style-type: none"> • Ramp can be covered with carpet or vinyl flooring tiles • Optional 3M™ Safety-Walk™ slip-resistant tape 		✓	

SUPERIOR DURABILITY & TROUBLE-FREE MAINTENANCE

CARRIAGES WHEELS & GUIDANCE SHELVING ANCHORING MOTOR

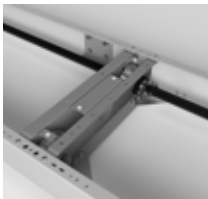

ALL-RAIL DIRECT-DRIVE SYSTEM

- Direct drive mechanism
- Full length drive shaft wheel at every rail location. This creates uniformly distributed pulling forces
- Large diameter torque-resistant drive shaft provides power to **all wheels** connected to the line shaft
- No multiple internal chain mechanisms and drive shafts which would require more maintenance
- Prevents fishtail with unbalanced loads
- Reduces stress on the carriage structure
- Enhances stability and performance
- Provides positive tracking effect
- Extends life of the systems



STEEL C-SHAPED CROSS MEMBERS & CARRIAGE JOINTS

- Steel C-shaped members provide great structural strength
- Carriage joints allow smaller carriage sections, which provide easier shipping and facilitate the installation of long carriages despite physical limitations such as elevators
- Allows the extension of existing carriages by adding sections
- Bolted from the inside to provide a clean exterior finish without visible hardware

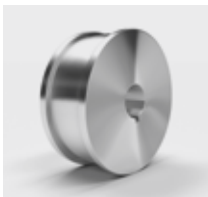

ALL 5" DIAMETER HARDENED STEEL WHEELS

- Provides larger turning diameter minimizing the number of wheel rotations and lowers the wear to the wheel
- Ensures a long-lasting system
- Provides greater strength
- Provides smooth and easy movement
- Prevents uneven wear since all wheels are the same diameter, as opposed to systems using a combination of 3-inch (76.2 mm) and 5-inch (127 mm) wheels



LIFETIME LUBRICATED & SHIELDED BALL BEARINGS

- Minimum load rating of 3,540 lb (1,605 kg) per wheel
- Ensures a long system life and a smooth movement
- Bearings are maintenance free and provide smooth and easy movement



TORQUE-RESISTANT TUBULAR DRIVE SHAFT

- Most durable shaft in the industry
- Lighter, stiffer and stronger structure
- Torsion resistance of 11,773 lb-in (1,330 N-m)
- Tubular drive shaft inside diameter: 1.045" (26.5 mm)
- Tubular drive shaft external diameter: 1.315" (33.4 mm)

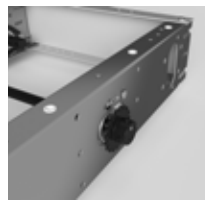

AERONAUTICAL RIVET BONDING CARRIAGE ASSEMBLY

- Prevents play and looseness thereby consistent and precise
- Expands when seated thus filling the space completely and providing maximum strength
- Eliminates distortion and reduces material stress caused by welding
- Facilitates system relocation
- Allows easy and economical carriage modifications



DOUBLE-FLANGED PRECISION-MACHINED 1045 HARDENED STEEL WHEELS

- Enables the system to move smoothly
- Minimizes vibration
- Minimizes wear and tear on the wheel thus reducing risk of maintenance problems
- Secure guidance even with an unbalanced system
- Rolling friction coefficient of less than 0.0117



BEST-IN-CLASS SHELVING ATTACHMENT TO MOBILE CARRIAGE

- Full C Channel construction
- Design allows no visible hardware on front face of carriage
- Montel SmartShelf® rests on 5" (127 mm) high steel carriage
- Montels bearing capacity is that of entire carriage
- SmartShelf® attached with two 4" (101.6 mm) bolts per frame versus only 3/4" (19 mm) tek screws as usually provided by other manufacturers

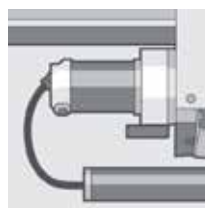

MOTORS & WIRE LOOMS

- Controlled Acceleration and Deceleration 90VDC Gearmotors
- Wire looms fully protect and prevent cables from rubbing on the floor or moving parts during carriage movement.
- Programmable Speeds (Start-Up/Cruising/Braking)
- Sequential Move/Block Move/Single Move/Override Move

EXCEPTIONAL PERFORMANCE DUE TO SUPERIOR QUALITY



SAFE AISLE®

A system's performance is proved over time, day after day, year after year. It's a matter of quality design, components, and installation. It's measured in superior durability and trouble-free maintenance. It's enhanced by the many special features that make our systems so pleasant to use. Simply put, we are performance professionals. Our systems are regularly tested by industrial research centers and independent laboratories. We continually invest in Research and Development to maintain and improve our reputation as a leader in quality. We capture the majority of bids where performance is the main selection criteria.

SAFE AISLE® OPTIONAL STAINLESS STEEL

SafeAisle® Stainless Steel selective components can withstand rough corrosive conditions and is ideally suited for clean rooms found in hospitals, pharmaceutical manufacturing, and also corrosive environments such as cold storage applications, freezers, food manufacturing, kitchens, and even offshore platforms.

SafeAisle® Stainless Steel components such as wheels and rails are made of stainless steel and drive shafts are treated with an anti-corrosion coating. Other components could be supplied in stainless steel on request upon factory's approval.



STAINLESS STEEL LOW PROFILE RAIL & WHEEL



SURFACE MOUNTED

ALUMINUM SUB-RAIL & STAINLESS STEEL RAIL



RECESSED OR FLOOR MOUNTED TRACK

WHEN FLEXIBILITY MEETS SPACE EFFICIENCY

PATENT # 6,814,245

SMART SHELF®

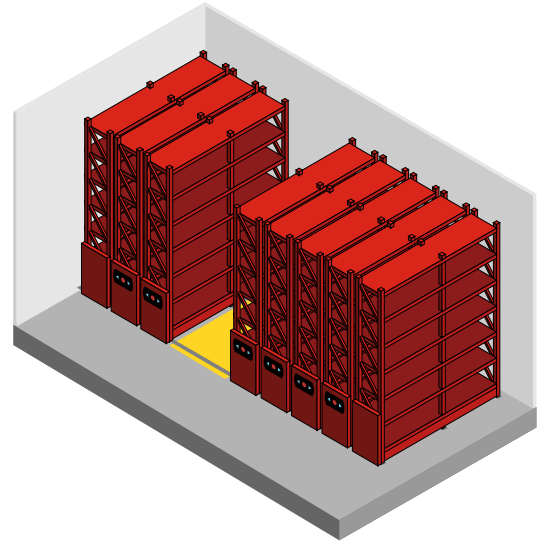

MOUNT SMARTSHELF® SHELVING SYSTEM ON SAFEAISLE® POWERED MOBILE SYSTEM AND INSTANTLY REALIZE POSITIVE GAINS WITHIN YOUR AVAILABLE SQUARE FOOTAGE.

SmartShelf® 4-Post hybrid shelving system mounted on Safeaisle® Powered Mobile Storage System

You can store anything with SmartShelf®. This new revolutionary shelving system was designed to be configured and reconfigured easily and efficiently. In fact, we offer the widest range of products in the market. We will go to any length, width or depth to optimize your space. The only good solution is a flexible solution.



YOU CAN ALSO MOUNT OTHER MONTEL SHELVING SYSTEMS ONTO SAFEAISLE® MOBILE CARRIAGES



AETNASTAK
CANTILEVER SHELVING
IDEAL FOR LIBRARY SHELVING.



CABINET-STYLE
CASE-TYPE SHELVING
IDEAL FOR OFFICE & CORPORATE STORAGE.

GET MORE VERTICAL & HORIZONTAL SPACE

WITH SMARTSHELF® & SAFEAISLE®

PATENT # 6,814,245



TAKE SPACE EFFICIENCY TO A NEW LEVEL | MAXIMIZE YOUR STORAGE | OPTIMIZE YOUR SPACE

Our continuous quest for space optimization has led us to develop SmartShelf®, a shelving system that exceeds industry standards.

MORE STORAGE VERTICALLY ADJUSTABLE SHELVES IN 1" (25.4 MM) INCREMENTS

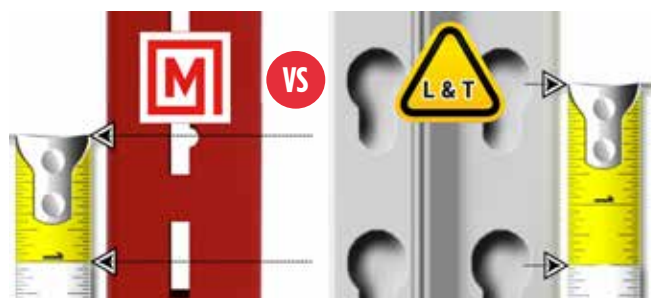

1" (25.4 MM)
SMARTSHELF® HYBRID SHELVING
SYSTEM WITH HOOKS

1 1/2" (38.1 MM)
L&T COMMODITY SHELVING

MORE STORAGE HORIZONTALLY 3/4" (19 MM) MORE USABLE STORAGE PER SHELF

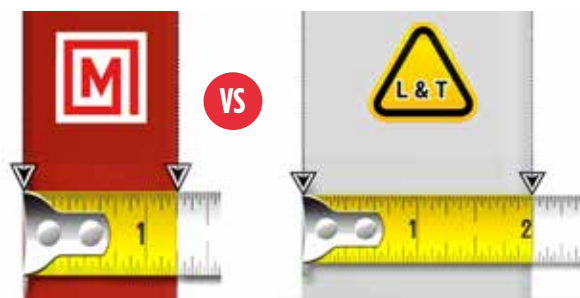

1 1/4" (31.75 MM)
SMARTSHELF® HYBRID SHELVING

2" (50.8 MM)
L&T COMMODITY SHELVING

DO THE SMARTSHELF® MATH

100 SECTIONS OF 97" (246.38 CM) HIGH
WITH 8 TIERS OF BACK-TO-BACK SHELVING
UNITS WOULD REPRESENT:

NOTE: WHAT ABOUT THE ADDITIONAL STORAGE VERTICALLY
DUE TO THE 1" INCREMENTS VS. L&T AT 1 1/2" INCREMENTS.
ADD THESE EXTRA LINEAR INCHES TO YOUR TOTAL.

8 TIERS
X 2 BACK-TO-BACK SHELVING UNITS
X 3/4" (19 MM) MORE STORAGE PER SHELF
= 12" (30.48 CM) MORE USABLE STORAGE PER SHELVING UNIT
X 100 SECTIONS

**= 1,200" (30.48 M) ADDITIONAL LINEAR INCHES
OF STORAGE WITH SMARTSHELF® VS. L&T**

COMBINED FLEXIBILITY TO STORE VIRTUALLY ANYTHING

EVERYTHING IS NOW POSSIBLE WITH SMARTSHELF® TAKE SPACE EFFICIENCY TO A NEW LEVEL

SmartShelf® is designed to be configured and reconfigured easily and efficiently. Shelves and accessories are interchangeable. That way, they can grow and evolve according to your future storage needs.

SMART SHELF®

PATENT # 6,814,245

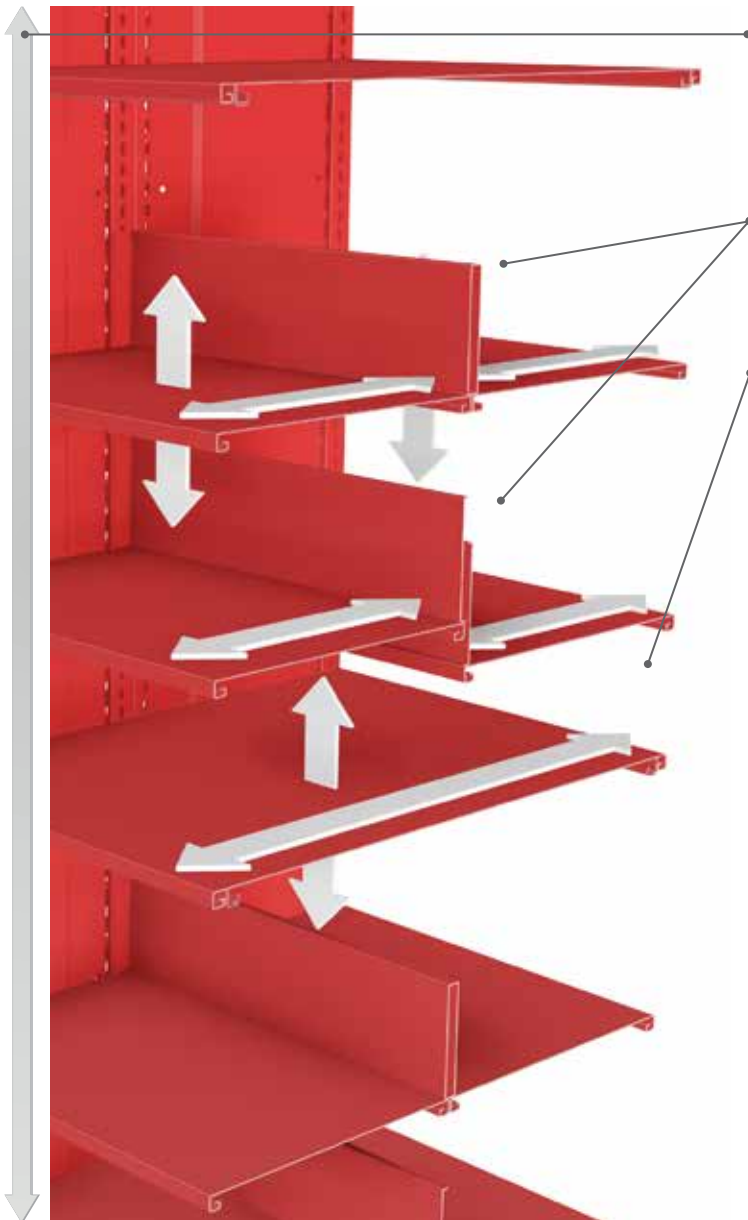

FROM ONE TIER TO THE NEXT

SmartShelf® is the only storage system that can be configured with back-to-back or double face full depth shelves, or any combination of both.

BACK-TO-BACK SHELVES

The shelf system is independently adjustable on both sides for many storage possibilities. Easy to assemble and reconfigure.

DOUBLE FACE FULL DEPTH SHELVES

For storing large objects of various lengths, shapes and sizes.

SHELVING SYSTEM WITH HOOKS: EASY TO RECONFIGURE & NO TOOLS REQUIRED



DID YOU KNOW?

Montel SmartShelf® shelving with hooks can hold up to 250 lb (113.4 kg) although can potentially withstand up to 500 lb (226.8 kg) depending on shelf dimensions.

SHELVING SYSTEM WITH SHELF SUPPORTS & REINFORCEMENTS | OPTIONAL



DID YOU KNOW?

Montel SmartShelf® shelving with supports and reinforcements can hold heavier objects than SmartShelf® shelving with hooks and can withstand up to 500 lb (226.8 kg).

ACCESSORIES

UNLIMITED POSSIBILITIES



BIN DIVIDERS



SLAT STEEL PANEL WITH UPFRONT DISPLAY SHELF & WORKING COMPUTER SHELF



FORKLIFT BASE



DRAWER CABINET WORKBENCH



SMARTSHELF® SHELVING RUN ON CASTERS WITH ROLLING SHUTTERS



AUTOMATIC OVERHEAD AISLE LIGHTING



STURDY PULL-OUT REFERENCE SHELF



WHITEBOARD END PANELS



MOBILEX® WITH PATENTED AISLE SAFETY BRAKE (1) | PULL-OUT DRAWERS (2)



ADA COMPLIANT RAMP



UNIVERSAL CROSSBARS WITH BIKE SUPPORT*



GARMENT RODS | BIN DIVIDERS | FRONT STOPS



WIRE SPOOL RODS



VERTICAL COMPARTMENTS | ARTWORK BINS



FRONT STOPS



UNIVERSAL CROSSBARS WITH HANGING RODS*



LARGE FRONT STOPS | GARMENT ROD



PULL-OUT DRAWERS



ROLLING SHUTTERS DOORS



SLIDING TRAY



COMPARTMENTS WITH HINGED DOORS | PERFORATED BACK PANELS



LOUVERED PANELS FOR PLASTIC BINS



ADJUSTABLE BINS ON EITHER SIDE



PERFORATED TRAY



MOBILE SYSTEM WITH UPFRONT STORAGE



COMPARTMENTS WITH HINGED DOORS | PERFORATED BACK PANELS



SLAT WALLS FACE PANELS (1), SLAT WALLS BACK PANELS (2), ADJUSTABLE HANGING BINS UPFRONT (3)



PERFORATED SHELVES



MOBILE SYSTEM WITH UPFRONT STORAGE



PERFORATED PANELS



ADJUSTABLE HANGING BINS UPFRONT



SMARTSHELF® MOBILE CABINET ON CASTERS

* PROVIDED WITH AETNASTAK CANTILEVER SHELVING

CASE STUDY

PITTSBURGH PENGUINS

PITTSBURGH PENGUINS SELECT MONTEL'S HOCKEY EQUIPMENT STORAGE SOLUTION





 PITTSBURGH, PA, UNITED STATES



SAFEAISLE® POWERED
MOBILE STORAGE SYSTEM

CHALLENGES

With the new construction of the CONSOL Energy Center, the National Hockey League franchised member club Pittsburgh Penguins needed efficient storage solutions to house their hockey equipment and gear.

SOLUTIONS

After determining the equipment and gear inventory, and reviewing the allocated storage space, an innovative custom-designed mobile & static storage solution was proposed for the Penguins' equipment storage room and laundry room.

PRODUCT FEATURES

Montel provided the following state-of-the-art athletic equipment high-density mobile and stationary shelving product configurations:

Equipment storage room:

- 6 high-density powered mobile carriages
- Impact-resistant infrared floor-level safety sweep
- Electronic motor overload protection
- Adjustable infrared proximity sensors
- Aeronautic riveted carriages
- Anti-tip protection
- Steel 144" high end panels with Penguins logo
- Powder coating finishing technology.

Laundry room:

- 3 high-density mechanical mobile carriages
- Aeronautic riveted carriages
- Ergonomic three-spoke zinc handles
- Anti-tip protection
- Steel 144" high end panels with Penguins logo
- Powder coating finishing technology
- 4-Post hybrid shelving.



CASE STUDY

HEC MONTREAL

A NEW POWERED COMPACT STORAGE SYSTEM FOR THE MYRIAM
ET J.-ROBERT OUIMET LIBRARY AT HEC MONTREAL.



HEC MONTRÉAL

 MONTREAL, QC



**SAFEAISLE® POWERED
MOBILE STORAGE SYSTEM**

“ The Montel product is really easy to use, the customer service is great and the system dramatically improves our efficiency. ”

CHALLENGE

HEC Montréal needed a state-of-the-art library storage system, one that met the high academic standards set by faculty and allowed learners to take full advantage of its collection of 300,000 monograph reference books and 1,400 periodicals.

SOLUTION

Redesign the academic library space, by offering less space for housing the collections and increasing the conducive study space for users, compact shelving will recover about 40% of the space occupied by the traditional stationary library space, providing more collaborative workspaces for students.

Montel helped HEC take that next step with a brand-new SafeAisle® powered mobile shelving system with Aetnastak cantilever library shelving.

PRODUCT FEATURES

Library staff must either find space or expand at a high cost. With its accordion design, powered mobile shelving condenses storage areas once consumed by legacy resources. Students retain access while the library continues to prioritize the future of higher education at every opportunity.

Each mobile shelving carriages comes with an intuitive LED-backlit controller mounted on both end panels. Students and staff need only press the arrow corresponding to the aisle they'd like opened and voilà – instant access.

HEC Montréal's mobile library storage uses Montel's patented **Aisle LED Guard™** technology (US Patent No. 9,507,05 / Canadian Patent NO.2,778,977) to prevent units from closing aisles with people or objects in between.

Sensors run the full length and width of the aisle along the bottom of the shelves. Once the LED beam is severed, the shelves lock in place. They cannot be overridden until the aisle is completely clear. Users wondering why their aisles won't close can read information off the displays accompanying each end-panel controller.

Every mobile shelving unit on HEC Montréal's library storage installation has its own independent aisle entry people counter. These devices activate the lights when one person enters, then turns the lights off once every counted user leaves. Because this special lighting only uses energy as needed, HEC Montréal cuts back on its consumption and saves money in operating costs.

Of course, visitors might not need every book in HEC Montréal's full catalog every day. As certain collections fall out of fashion, librarians need the ability to switch up storage without buying completely new shelving.

Montel's mobile shelving gives HEC staff the freedom to reorganize at their leisure with 1-inch incremental adjustability on every shelves. Better yet, shelves don't need fancy tools to be moved.

WE BUILD SATISFACTION

Established in 1924, Montel pioneered high density mobile storage systems providing cost-efficient storage solutions using less space.

CUSTOM-BUILT FOR YOUR INDUSTRY
WE'VE MANUFACTURED AND INSTALLED THOUSANDS OF PROJECTS AROUND THE WORLD.



MOBILEX® POWERED MOBILE SYSTEM WITH 4D WIDE SPAN RACKING



SMARTSHELF® 4-POST HYBRID SHELVING SYSTEM



HI-BAY SHELVING SYSTEM FOR LEAFY GREENS



SAFEAISLE® POWERED MOBILE SHELVING SYSTEM



MOBILEX® MECHANICAL-ASSIST MOBILE SHELVING SYSTEM



SAFERAK® 32P POWERED MOBILE RACKING SYSTEM FOR COLD STORAGE

WHAT ELSE DO WE DO?
STORAGE SOLUTIONS THAT HELP YOU TO GROW FROM THE INSIDE, OPTIMIZE AND GET RESULTS.



HEAVY-DUTY MOBILE STORAGE SYSTEMS



SHELVING SYSTEMS



INDUSTRIAL MODULAR DRAWERS



MOBILE DRAWER CABINETS & OTHER LIGHT-DUTY AND HEAVY-DUTY CABINETS

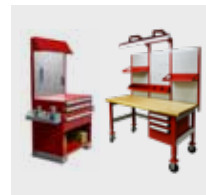

WORKSTATIONS & WORKBENCHES



HANGING STORAGE SCREENS & PANELS

WHY CHOOSE MONTEL STORAGE SOLUTIONS?

SAVE SPACE | SAVE TIME | SAVE MONEY



GET RESULTS FROM YOUR SQUARE FOOTAGE: FAST ROI

Save up to 50 % of your value generating space.



WORK WITH STORAGE-SAVVY EXPERTS

We manufacture the one and only solution. The best one.



TOTAL OFFER CUSTOMIZED TO YOUR NEEDS

We will go to any length, depth, width, height, and weight.



BETTER ORGANIZE YOUR SKUs

Gain productivity while inventory management & security are improved.



MEET YOUR ENVIRONMENTAL OBJECTIVES

Minimize your environmental impact by reducing your footprint.

OUR MISSION

THE EMPLOYEES OF MONTEL SET OUT A VERY PERSONAL OBJECTIVE: BUILD THE BEST STORAGE SYSTEMS IN THE WORLD.

Their talent, commitment and dedication have been put to the test numerous times.

At Montel, client satisfaction is an ongoing priority. Our highly competent Authorized Montel Distributors are specialists in providing turnkey project solutions including space planning, design and floor loading consulting services, and factory certified system installations. They are also committed to providing a high level of professionalism and an outstanding customer service before and after the sale.

MONTEL INTERNATIONAL PRESENCE



72
COUNTRIES

MONTEL ACHIEVED PRESTIGIOUS REALIZATIONS IN MORE THAN 72 COUNTRIES

65
DISTRIBUTORS

65 AUTHORIZED MONTEL DISTRIBUTORS AROUND THE WORLD

SINCE
1924

MORE THAN 9 DECADES OF INNOVATIVE STORAGE SOLUTIONS

ALSO AVAILABLE

INQUIRE ABOUT OTHER MONTEL HIGH-DENSITY MOBILE STORAGE SYSTEMS DESIGNED TO HOLD VARIOUS LOAD CAPACITIES. MOBILE SYSTEMS ARE EITHER POWERED ELECTRICALLY, OPERATED MECHANICALLY OR MANUALLY.



MOBILEX®



RACK&ROLL 16MA



QUADRAL



SMARTSPACE 2MA

CERTIFICATIONS & STANDARDS



For the most recent version of this document, please go to the Montel website at www.montel.com/en/design-center. In case of discrepancy, the web version takes precedence over any printed literature.



877-935-0236
info@montel.com
www.montel.com